

Tobler Storage



- Cantilever racks
- Lattice and stackable boxes
- Buffer storage
- Pallet racks
- Pallets and storage racks
- Rolling scaffoldings



Tobler Storage

Organizing more efficiently.

Building begins with efficient storage and safe transport



Tobler has been serving customers with top products for storage and transport to site since 1995.



Tobler storage products need to stand up to tough everyday use – and we have only the best.



Ideal cost-effectiveness, time and time again

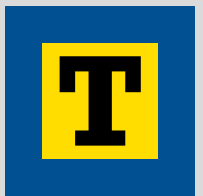

Our products for your storage

1. Cantilever rack storage	4 – 11
2. Pallet rack storage	12 – 13
3. Custom solutions	14
4. Innovations for customers	16
5. Lattice boxes and racks	17 – 19
6. Buffer storage with MATO 8	20
7. Rolling scaffolding with MATOR	21
8. Tobler mission statement	22
9. Tobler products – full overview	23



Tobler Storage

Cantilever storage.

Flexible planning

The cantilever rack is available in both a single and double-sided design and can be completely tailored to your needs in terms of size, load-bearing capacity, statics and accessories.

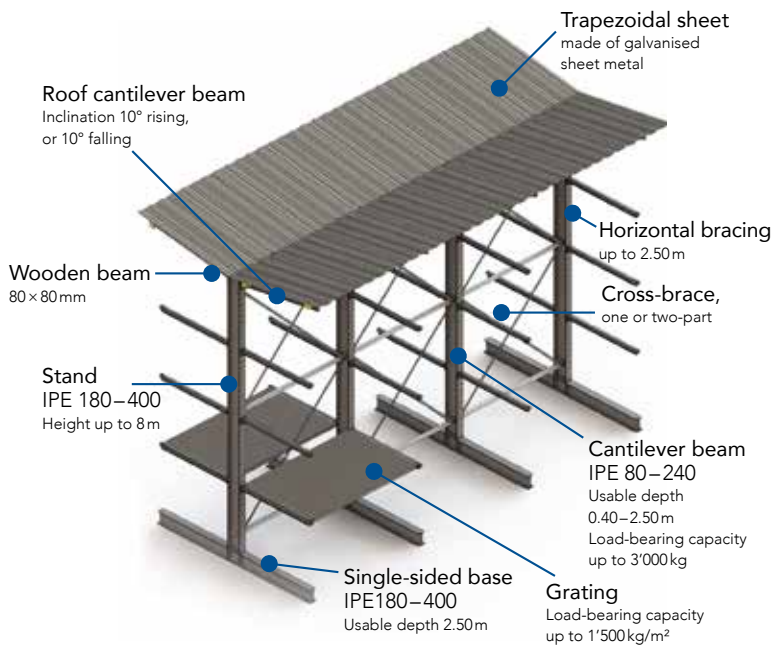

Each cantilever rack is individually designed and analysed. The load per beam and required usable depth are the design parameters for the cantilevers.

Design parameters

Standard values:

Bay lengths	Usable depth < 1 m	Usable depth from 1 m
80 cm	40 cm	100 cm
100 cm	50 cm	125 cm
125 cm	60 cm	150 cm
150 cm	70 cm	175 cm
200 cm	80 cm	200 cm
250 cm	90 cm	250 cm

On request, we can also supply **custom dimensions**.

Sturdy wooden floor structures with **underbridge beams** are also popular as an alternative to gratings (1).

As an example, a usable depth of 125 cm and a bay length of 250 cm allow for 3 Euro pallets to be stored between two stands.

The **roofs** mounted on wooden beams have a 10° rising or falling (2) inclination. They are made of trapezoidal sheet metal, which is available in lengths of up to 7 m.



1 Underbridge beam on cantilever beams



2 Roof on roof cantilever beam and wooden beam 8 x 8 cm

Tobler Storage

Cantilever storage.



Exceptionally stable

The cantilever rack is extremely durable thanks to its welded steel profiles and means storage space can be used cost-effectively.

The cross-braces and horizontal braces (3) matched to the bay length provide additional strength.



3 Cross-braces and horizontal braces for a secure bond

Upon request, all rack systems can be assembled by Tobler specialists and subsequently tested by rack inspectors in accordance with DIN EN 15635.

This ensures that you're always on the safe side with Tobler, even for **custom applications** (4).



4 Mobile cantilever rack

Available
online

Benefits

- robust and with a high load-bearing capacity
- customised manufacture
- can be extended and modified at any time
- limitless design options
- single and double-sided designs
- various locking mechanisms available

The «indestructible» rack

EN 1090

TESTED



0769

This product complies with the applicable health and safety protection requirements within the EU and EEA.

Tobler Storage

Cantilever storage.

Cantilever racks

Designation	Load-bearing capacity per arm	Shelves	Bay length	Usable depth
Single-sided basic shelf, galvanised steel, Profile: IPE 180–300	Usable depth: 125 cm IPE 80 / 450 kg IPE 180 / 1'840 kg	4 rows	80–250 cm	40–250 cm

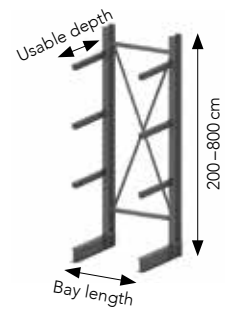

Single-sided extension, galvanised steel, Profile: IPE 180–300	Usable depth: 125 cm IPE 80 / 450 kg IPE 180 / 1'840 kg	4 rows	80–250 cm	40–250 cm
--	---	--------	-----------	-----------

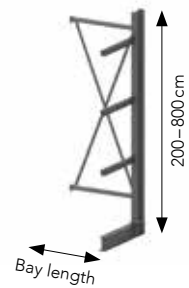

Double-sided basic shelf, galvanised steel, Profile: IPE 180–300	Usable depth: 125 cm IPE 80 / 450 kg IPE 180 / 1'840 kg	4 rows	80–250 cm	40–250 cm
--	---	--------	-----------	-----------

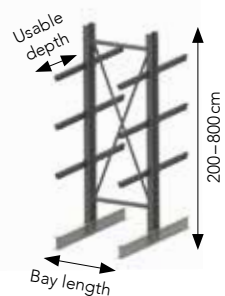

Double-sided extension, galvanised steel, Profile: IPE 180–300	Usable depth: 125 cm IPE 80 / 450 kg IPE 180 / 1'840 kg	4 rows	80–250 cm	40–250 cm
--	---	--------	-----------	-----------

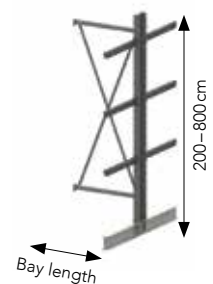

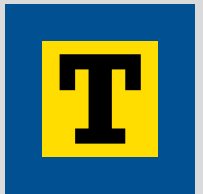

Standard models with extension elements

Article no.	Designation	Quantity
77-183012B	Double-sided IPE 180 stand, H: 300 cm, 56.5 kg	3
77-183012A	Single-sided base (support base), IPE 180, usable depth: 125 cm, 29.7 kg	3
77-080125	Narrow IPE 80 cantilever beam, usable depth: 125 cm, 9.0 kg, load-bearing capacity: 450 kg	9
77-150000	Horizontal bracing, L: 150 cm, 5.1 kg	4
77-150300	Single piece cross-brace, H: 300 cm, L: 150 cm, 6.7 kg	1



SET 1

77-183012B	Double-sided IPE 180 stand, H: 300 cm, 56.5 kg	3
77-193012C	Double-sided base (support base), IPE 180 usable depth: 125 cm, 54.3 kg	3
77-080125	Narrow IPE 80 cantilever beam usable depth: 125 cm, 9.0 kg, load-bearing capacity: 450 kg	18
77-150000	Horizontal bracing, L: 150 cm, 5.1 kg	4
77-150300	Single piece cross-brace, H: 300 cm, L: 150 cm, 6.7 kg	1



SET 2

77-183012B	Double-sided IPE 180 stand, H: 300 cm, 56.5 kg	1
77-183012A	Single-sided base (support base), IPE 180, usable depth: 125 cm, 29.7 kg	1
77-080125	Narrow IPE 80 cantilever beam, usable depth: 125 cm, 9.0 kg, load-bearing capacity: 450 kg	3
77-150000	Horizontal bracing, L: 150 cm, 5.1 kg	2
77-150300	Single piece cross-brace, H: 300 cm, L: 150 cm, 6.7 kg	1



SET 3

77-183012B	Double-sided IPE 180 stand, H: 300 cm, 56.5 kg	1
77-193012C	Double-sided base (support base), IPE 180 usable depth: 125 cm, 54.3 kg	1
77-080125	Narrow IPE 80 cantilever beam, usable depth: 125 cm, 9.0 kg, load-bearing capacity: 450 kg	6
77-150000	Horizontal bracing, L: 150 cm, 5.1 kg	2
77-150300	Single piece cross-brace, H: 300 cm, L: 150 cm, 6.7 kg	1



SET 4

Tobler Storage

Cantilever storage.

Roof

Article no.	Designation
Example: 77-527350	Cantilever beam to IPE 240, 270, 300, Usable depth 350 cm, 10° rising
77-526080 to 77-526125	10° down, hole spacing 55 mm: IPE 80 IPE 100
77-526150 to 77-526200 77-528080 to 77-528100 77-528150 to 77-528250 77-213500	10° down, hole spacing 60 mm: IPE 240, IPE 270, IPE 300 IPE 240, IPE 270, IPE 300
77-527350	10° up, hole spacing 60 mm: IPE 240, IPE 270, IPE 300
Example: 77-870100	Roof, trapezoidal sheet metal Width 82 cm Length 100 cm
77-870100 to 77-870350	Width 82 cm Length 100 cm to 350 cm
77-871100 to 77-871350	Width 102 cm Length 100 cm to 350 cm
77-872125 to 77-872750	Width 84 cm Length 100 cm to 750 cm Powder-coated, green
77-873300	Length 300 cm
Example: 77-188300	Wooden beam Cross section 8 × 8 cm Length 300 cm
77-188300 to 77-188650	Cross section 8 × 8 cm Length 300 cm to 650 cm
77-70001	Sheet metal connection to wooden beam, cross section 8 × 8 cm
Example: 77-189300	Steel C-profile Height 80 cm width 40 cm length 300 cm
77-189300 to 77-189600	Length 300 cm to 600 cm

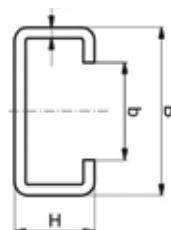
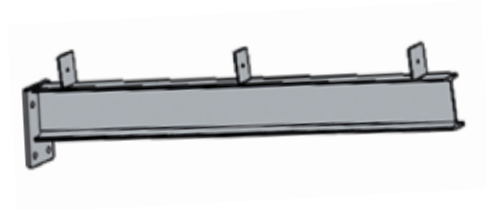

B = 80 mm
H = 40 mm
b = 40 mm
s = 3 mm

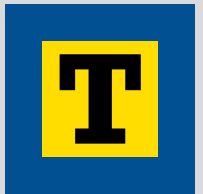

Cantilever beam

Article no.	Designation
Example: 77-080125	Narrow IPE 80 cantilever beam, Usable depth: 125 cm , 9.0 kg Load-bearing capacity 450 kg
	Cantilever beam hole spacing 55mm:
77-080040 to 77-080200	IPE 80
77-100040 to 77-100200	IPE 100
77-120040 to 77-120200	IPE 120
77-140040 to 77-140200	IPE 140
77-160040 to 77-160200	IPE 160
77-180040 to 77-180200	IPE 180
77-200040 to 77-200200	IPE 200
	Cantilever beam hole spacing 60mm:
77-081040 to 77-081200	IPE 80
77-101040 to 77-101200	IPE 100
77-121040 to 77-121200	IPE 120
77-141040 to 77-141200	IPE 140
77-161040 to 77-161200	IPE 160
77-181040 to 77-181200	IPE 180
77-201040 to 77-201200	IPE 200



Grating

Example: 77-701102	Grating Length = bay length 80cm Depth 125 cm
77-701100 to 77-701105	Bay length 80cm Depth 80 cm to 250 cm
77-701106 to 77-701111	Bay length 100cm Depth 80 cm to 250 cm
77-701112 to 77-701117	Bay length 125cm Depth 80 cm to 250 cm
77-701118 to 77-701123	Bay length 150cm Depth 80 cm to 250 cm
77-701124 to 77-701129	Bay length 175cm Depth 80 cm to 250 cm
77-701130 to 77-701135	Bay length 200cm Depth 80 cm to 250 cm



Fastening for grating	is screwed directly onto IPE profile, no new holes required
-----------------------	--



Tobler Storage

Cantilever storage.

Bases and stands

Article no.	Designation
Example: 77-183012A	Single-sided base (support base), IPE 180, usable depth: 125 cm, 29.7 kg
	Single-sided bases acc. to profile:
77-182004A to 77-183520A	IPE 180
77-203004A to 77-205020A	IPE 200
77-223004A to 77-225020A	IPE 220
77-243004A to 77-247020A	IPE 240
77-273004A to 77-278020A	IPE 270
77-303004A to 77-308020A	IPE 300
Example: 77-193012C	Double-sided base (support base), IPE 180, usable depth: 125 cm, 54.3 kg
	Double-sided bases acc. to profile:
77-192004C to 77-193520C	IPE 180
77-213004C to 77-215020C	IPE 200
77-233004C to 77-235020C	IPE 220
77-254004C to 77-258017C	IPE 240
77-284004C to 77-288020C	IPE 270
77-313004C to 77-318020C	IPE 300
Example: 77-183012	Stands Double-sided 180, Height: 300 cm, usable depth 125 cm, weight: 56.5 kg
	Single-sided stands acc. to profile:
77-182004 to 77-193520	IPE 180
77-203004 to 77-205020	IPE 200
77-223004 to 77-225020	IPE 220
77-243004 to 77-247020	IPE 240
77-273004 to 77-278020	IPE 270
77-303004 to 77-308020	IPE 300
	Double-sided stands acc. to profile:
77-192004 to 77-193520	IPE 180
77-213004 to 77-215512	IPE 200
77-233504 to 77-235020	IPE 220
77-254004 to 77-258017	IPE 240
77-284010 to 77-288020	IPE 270
77-314010 to 77-318025	IPE 300

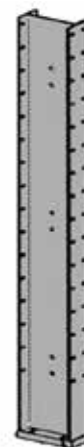
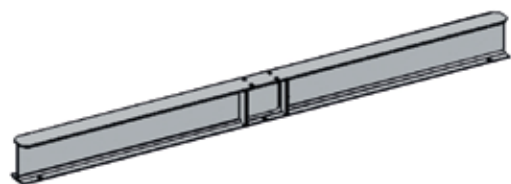
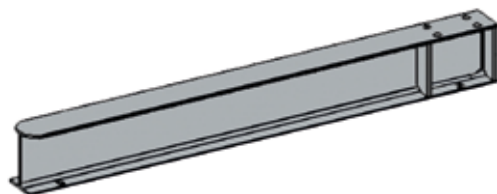

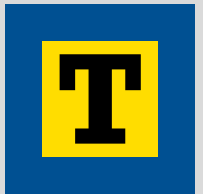

Horizontal bracing

Article no.	Designation
Example: 77-100000	L-profile horizontal bracing Length 100 cm
77-080000 to 77-270000	L-profile, horizontal bracing Bay length = 80–250 cm

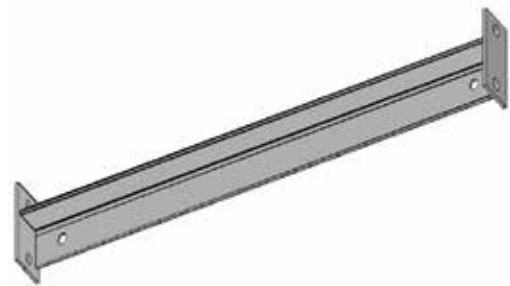

Cross-brace

Example: 77-080201	Cross-brace, flat profile 4 × 40 mm Length = bay length 80 cm Height 125 cm
77-080201 to 77-080350	Bay length 80 cm Height 200 cm to 350 cm
77-100201 to 77-100350	Bay length 100 cm Height 100 cm to 350 cm
77-125201 to 77-125350	Bay length 125 cm Height 200 cm to 350 cm
77-150201 to 77-150201	Bay length 150 cm Height 200 cm to 350 cm
77-200201 to 77-200350	Bay length 200 cm Height 200 cm to 350 cm



Example: 77-080400	Cross-brace Flat profile 4 × 40 mm Length = bay length 80 cm Height 125 cm
77-080400 to 77-080350	Bay length 80 cm Height 400 cm to 600 cm
77-100400 to 77-100350	Bay length 100 cm Height 400 cm to 700 cm
77-125400 to 77-125350	Bay length 125 cm Height 400 cm to 600 cm
77-145550	Bay length 145 cm Height 550 cm
77-150400 to 77-150201	Bay length 150 cm Height 400 cm to 700 cm
77-180500	Bay length 180 cm Height 500 cm
77-190700	Bay length 190 cm Height 700 cm
77-200400 to 77-200750	Bay length 200 cm Height 400 cm to 750 cm
77-250400	Bay length 250 cm Height 400 cm



Tobler Storage

Pallet rack storage.

Pallet rack for indoor and outdoor use

This storage system is designed for universal use and allows for efficient use of the storage capacity whilst providing direct access to individual pallets. It is ideal for Euro pallets, lattice boxes and any kind of stored goods up to 16m in height.

The pallet rack can be designed and configured for any length (load up to 30'000kg/m). A hot-dip galvanised version is available for indoor and outdoor use, as well as a more cost-effective painted or powder-coated version. Our product range also has a comprehensive range of accessories such as collision guards and push-through guards.

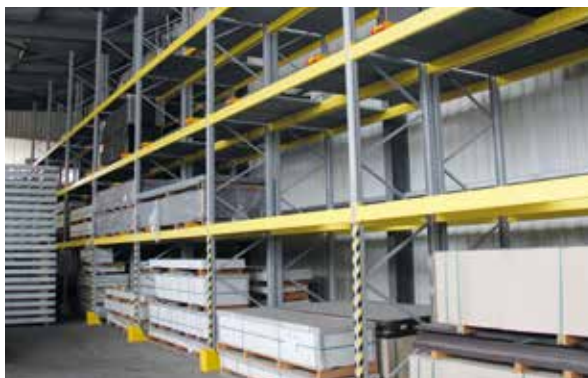
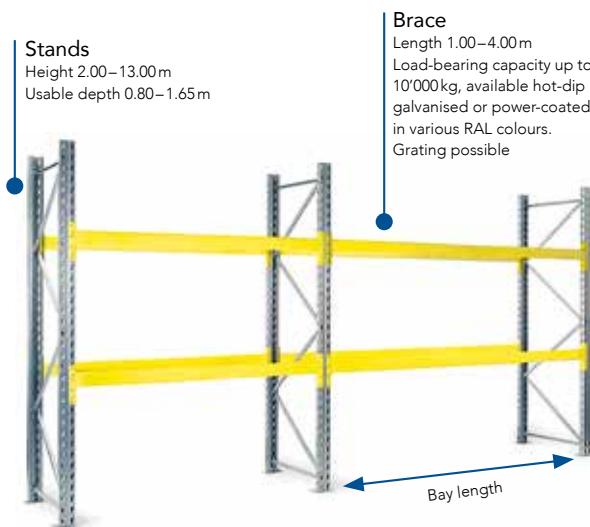

Pallet rack

Available online

Benefits

- fast and simple assembly
- designed for indoor and outdoor use
- individually adaptable
- freely expandable
- direct access to every pallet
- plenty of storage space
- comprehensive range of accessories
- available online

EN 1090 **TESTED**

CE
0769

This product complies with the applicable health and safety protection requirements within the EU and EEA.

The «flexible» rack



Grating for pallet rack

Tobler Storage

Pallet rack storage.



Pallet racks for every load

Designation	Load-bearing capacity Pair of braces	Shelves	Dimensions
Standard pallet rack, galvanised steel, powder-coated	up to 10'000 kg	Adjustable in 5 cm increments	D: 0.80–1.65 m H: 2.00–13.00 m L: 1.00–4.00 m



SET 1

Standard add-on shelf, galvanised steel, powder-coated	up to 10'000 kg	Adjustable in 5 cm increments	D: 0.80–1.65 m H: 2.00–13.00 m L: 1.00–4.00 m
--	-----------------	-------------------------------------	---



SET 2

Grating

- Available in various sizes, enabling a load-bearing capacity of **up to 1,500 kg**.



Collision guard

- With a **collision guard** for **corners** (1), **stands** (2) and **faces** (3), you can reliably protect your pallet rack storage systems from damage caused by vehicles.



1

2

3

Push-through guard

- Protect your goods from falls with the push-through guard that prevents incorrect loads.



Tobler Storage

Custom solutions.

Cantilever rack

Number of stands		units
Height of stands		cm
Beams per stand		units
Usable depth		cm
Load per beam		kg
Bay length		cm
Grating		units
Roof	<input type="checkbox"/> 10° falling	<input type="checkbox"/> 10° rising
With assembly, incl. acceptance and inspection according to DIN 15635	<input type="checkbox"/> Yes	<input type="checkbox"/> No

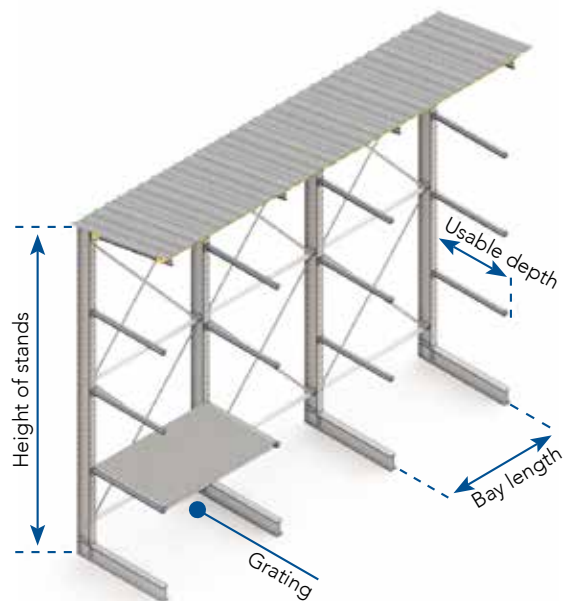
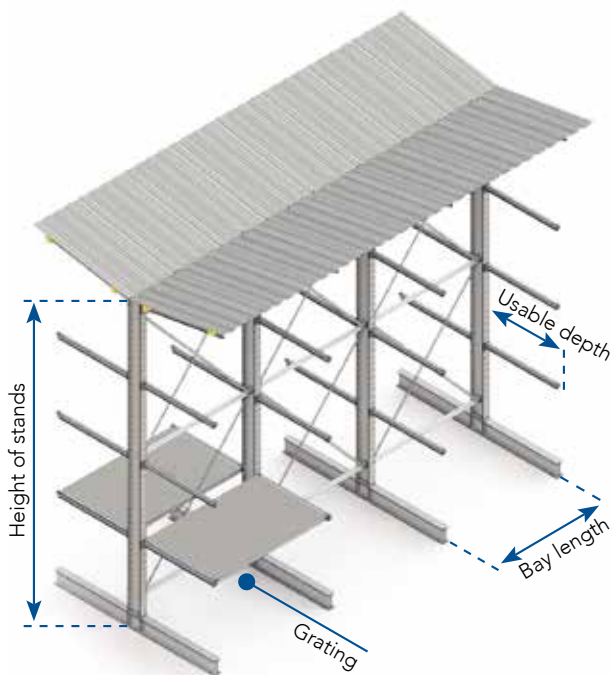



Pallet rack

Number of stands		units
Height of stands		cm
Braces / level		units
Load per level		kg
Bay length		cm
Location	<input type="checkbox"/> Indoor	<input type="checkbox"/> Outdoor
Surface	<input type="checkbox"/> Galvanised	<input type="checkbox"/> Powder-coated
With assembly, incl. acceptance and inspection according to DIN 15635	<input type="checkbox"/> Yes	<input type="checkbox"/> No

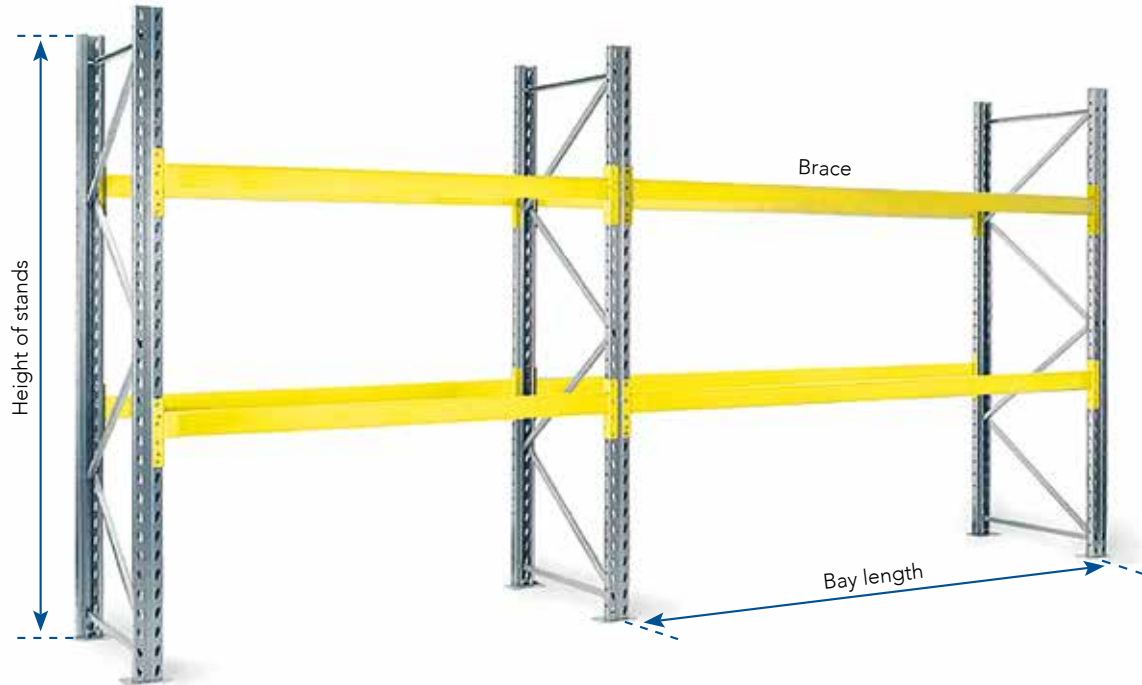

The quote form

Tell us what you need. We'll take care of the rest.
The fastest way is via our website:

<https://www.tobler-ag.com/en/storage-systems/>

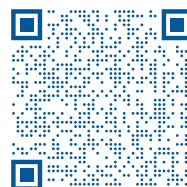

**Available
online**

Tobler Storage

Innovations for customers.

We see the big picture

Optimising your energy costs and reducing your transport costs are very important to us.

We're therefore happy to carry out the most demanding tasks for you, such as installation of a solar roof on a cantilever rack.

To guarantee maximum safety, we always use structural analyses.

And our engineers use the latest, cutting-edge software to perform these analyses.

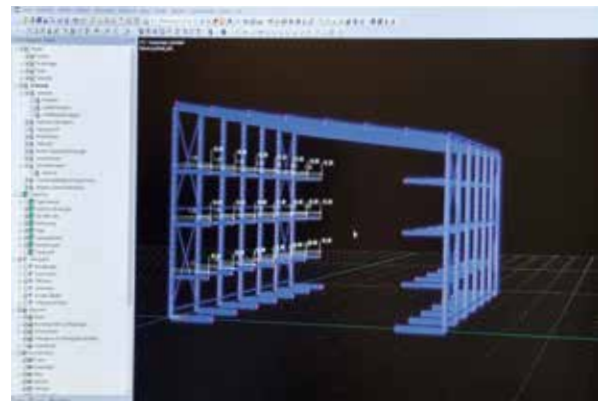

Tobler Storage

Lattice and stackable boxes.



Safely stored and stacked

Our lattice boxes are a space-saving solution for secure storage in the building yard, during transport and on the construction site.

Tobler pallets and storage racks feature impressive strength, stability and durability.

Goods can therefore be stacked safely at any height.



Lattice box with lengthwise folding part

- 4 units, stackable

Article no.	Length	Width	Height	Load-bearing capacity
B-210060	60 cm	80 cm	50 cm	2.0 t
B-210120	120 cm	80 cm	80 cm	2.0 t



Stackable box with open sides

Article no.	Length	Width	Height	Load-bearing capacity
B-211060	60 cm	80 cm	50 cm	1.5 t
B-211120	120 cm	80 cm	80 cm	1.5 t



Stackable box, open all around

Article no.	Length	Width	Height	Load-bearing capacity
B-212060	60 cm	80 cm	50 cm	1.5 t
B-212120	120 cm	80 cm	80 cm	1.5 t
B-212240	240 cm	80 cm	80 cm	1.5 t

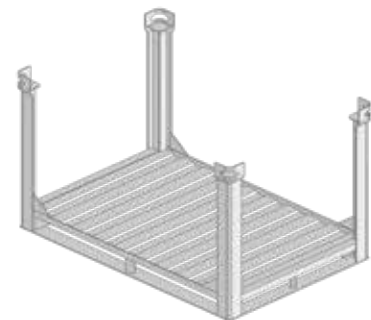

Steel box with flap

- 4 units, stackable

Article no.	Length	Width	Height	Load-bearing capacity
B-216060	60 cm	80 cm	50 cm	2.0 t
B-216120	120 cm	80 cm	50 cm	2.0 t

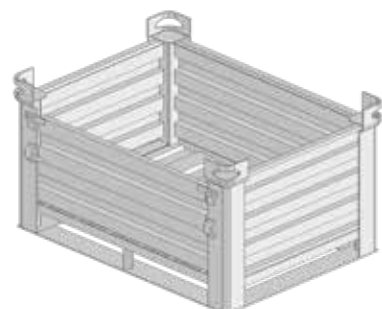

Tobler Storage

Pallets and storage racks.

We're flexible

Among others, we've optimised the transport of empty storage racks for you. Thanks to removable corner bars, you can reduce the transport volume.

We also produce lattice boxes and storage racks to **customer specifications**.



Steel tube pallet

Article no.	Length	Width	Height	Load-bearing capacity
54-B-212085	85 cm	85 cm	87 cm	1.5 t
54-B-212120	125 cm	85 cm	87 cm	1.5 t



Pallet for long items

Article no.	Length	Width	Height	Load-bearing capacity
52-1911010	60 cm	120 cm	68 cm	2.0 t
52-1911011	100 cm	120 cm	68 cm	2.0 t



Transport frames

Article no.	Length	Width	Height	Load-bearing capacity	Type
52-1912005	105 cm	103 cm	78 cm	1.0 t	TR-Tritt
52-1912015	160 cm	103 cm	47 cm	1.0 t	div.AR-CS
52-1912020	160 cm	103 cm	78 cm	1.0 t	B-Brett

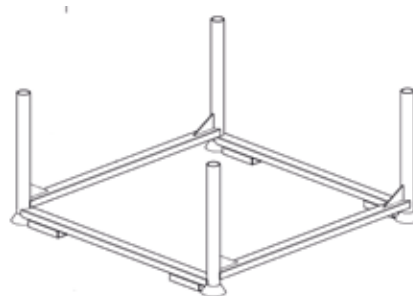

Storage rack for props

Article no.	Length	Width	Height	Load-bearing capacity
84-F-210080	120 cm	80 cm	70 cm	2.0 t



Tobler Storage

Lattice boxes and pallets.



Storage rack for props with anti-fall protection

- made of galvanised steel
- e.g. for all prop types in categories E, D, B

The robust design of the Tobler storage rack is ideal for secure transport and storage of long items such as props.



Article no.	Length	Width	Weight	Load-bearing capacity	Additional load
84-F-212080	160–310 cm	80 cm	93 kg	1'500 kg	4'500 kg



The unique, enclosed storage rack can be adjusted to any length, all with that renowned Tobler quality.

Thanks to the integrated anti-fall protection, complete safety is ensured during transportation and handling on the construction site.



Lengths adjustable from 1.60 – 3.10 m

Benefits

- extremely safe during transport owing to lateral anti-fall protection
- can be adjusted to any length
- tested to EN 1090
- new to the Swiss market

EN 1090

TESTED



This product complies with the applicable health and safety protection requirements within the EU and EEA.

MATO 8 Buffer storage

Use every available space for storage.

Don't waste any more valuable storage space

With our MATO 8 modular scaffolding, you can use every last bit of available space for your buffer storage, even in the tightest spaces.



Find out more in our **MATO 8** catalogue.

MATOR

Work safely and quickly on rollers.

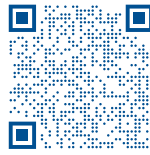

Video

Assembly by 1 person



TESTED

This product complies with the applicable health and safety protection requirements within the EU and EEA.

The «moveable» rack

Tobler Mission statement

Efficiency. Flexibility. Safety.



Mission statement

Together we implement solutions that are centred around the customer and their success.

We support you as a reliable partner for all matters relating to scaffolding and formwork assembly, and develop customer-specific solutions – from planning through engineering to production.

As an innovative full-service provider, we think ahead. We carry our philosophy of efficient, flexible and safe construction further into the industry.

With our products you can rely on excellent functionality and the highest production quality.



Swiss Engineering.
Swiss Technology.



Tobler Products

Enjoying industrialized construction.



MATO Scaffolding

	MATO 1	Facade scaffolding.
	MATO 2	Facade scaffolding.
	MATO 3	All-in-one scaffolding systems.
	MATO 8	Modular scaffold system.
	MATO C	Compatible systems.
	MATO Connect	Bridging systems.
	MATO Pro	Roof scaffolding systems.
	MATO R	Rolling towers.
	MATO T	Scaffoldings for construction sites.
	MATO Z	Scaffolding accessories.

Tobler Construction

	Tobler Industry	Mounting safely.
	Tobler Trading	Buying at a reasonable price.
	Tobler Storage	Creating order more efficiently.
	Tobler Nature	Safe off-road.
	Tobler Special	Custom-made products made to measure.

Tobler Formwork

	Tobler Rex	Girder wall formworks.
	Tobler Varia	Special formworks.
	Tobler Desk	Slab tables.
	Tobler Flex	Props, beams, panels.
	Tobler Project	Special formworks.
	Tobler Top	Wall formwork.
	Tobler Manu	Handset formwork.
	Tobler Deck	Slab formwork.
	Tobler Tower	Heavy duty supports.
	Tobler Rent	Rental park.
	Tobler Care	Renovation.

Tobler Occasions

	Tobler Occasions Formworking	Good, even used.
	Tobler Occasions Scaffolding	Worth the price.



At home in Switzerland – anchored in Europe

We are constantly driving forward the internationalisation of our product range.



**Order
& advice**
bestellung@tobler-ag.com
+41 71 886 06 06

Online order

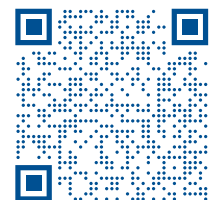

« Take advantage of the unique expertise of our experienced engineers in planning and realising your new cost-effective and efficient storage. »



John Penman
Sales field service
Storage Technology

